

Serie Valves

Valvole Elettropneumatiche

Solenoid Valve
Elektropneumatische Ventile
Distributeurs Électropneumatiques
Válvulas Electroneumáticas
Válvulas Eletro-pneumáticas



Serie 01V - X1V

Pag. 17.6 - 17.16

Valvole Asservite

Assisted Valve
Ventile Vorgesteuert
Distributeurs à Commande Assistée
Válvula Asistida
Válvula Piloto Externo



Serie 01V

Pag. 17.17 - 17.29

Valvole Pneumatiche

Pneumatic Valve
Pneumatische Ventile
Distributeurs Pneumatiques
Válvulas Neumáticas
Válvulas Pneumáticas



Serie 01V

Pag. 17.30 - 17.36

Valvole ad Azionamento Manuale

Manual Valve
Manuell Betätigte Ventile
Distributeurs à Commandes Manuel
Válvulas de Accionamiento Manual
Válvulas de Acionamento Manual



Serie 01V - X1V

Pag. 17.37 - 17.47

Valvole ad azionamento meccanico

Mechanically actuated valve
Mechanisch betätigte ventile
Distributeurs à commandes mécaniques
Válvulas de accionamiento mecánico
Válvula de accionamento mecánico



Serie 01V

Pag. 17.48 - 17.51

Basi Multiple

Multiple Bases
Mehrfach Grundplatten
Embases Multiples
Base Múltiple
Bases Múltiplas

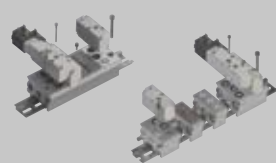

Serie 01V

Pag. 17.52 - 17.56

Micro Valvole

Micro Valves
Mikroventile
Microdistributeur
Microválvulas
Micro-Válvulas



Serie 02V

Pag. 17.58 - 17.60

Valvole 16 mm

16 mm Valves
Ventile 16 mm
Distributeurs 16 mm
Válvulas 16 mm
Válvulas 16 mm



Serie 03V

Pag. 17.62 - 17.66

Valvole a Pannello, Pulsanti e Selettori

Panel Valve, Push Buttons and Selectors
Schalttafelventile, Taster und Schalter
Distributeurs pour commandes en panneau et boutons
Válvulas de Panel, Pulsadores, Selectores
Válvulas para Painel, Pulsantes e Seletoras



Serie 04V

Pag. 17.68 - 17.70

Valvole VDMA 18 mm - Basi per Valvole VDMA 18 mm

18 mm VDMA Valve - 18 mm VDMA Bases
Ventile 18 mm VDMA - 18 mm VDMA Mehrfach Grundplatten
Distributeurs 18 mm VDMA - Embases multiples pour
Distributeurs 18 mm VDMA
Válvulas VDMA 18 mm - Base para Válvula VDMA 18 mm
Válvulas VDMA 18 mm - Bases Para Válvulas Vdma 18 mm



Serie 05V

Pag. 17.72 - 17.82

Valvole a Pedale

Pedal Valve
Valvole a Pedale
Distributeurs à Pédale
Válvulas a Pedal
Válvulas Pedal



Serie 06V

Pag. 17.84 - 17.85

Elettropiloti

Solenoid Valve
Magnetventile
Electro Distributeurs
Electropilotos
Válvulas Solenóide



Serie 07V

Pag. 17.87 - 17.89

Elettropiloti Miniaturizzati 10 mm e 15 mm

Miniature Solenoid Valve 10 mm and 15 mm
Miniatur Ventile 10 mm und 15 mm
Distributeurs Miniature au pluriel 10 mm et 15 mm
Electropiloto Miniaturizado 10 mm y 15 mm
Eletropilotos Miniaturizados 10 mm e 15mm



Serie 07V

Pag. 17.90 - 17.96

Valvole NAMUR

NAMUR Valve
NAMUR Ventile
Distributeurs NAMUR
Válvulas NAMUR
Válvulas NAMUR



Serie 08V

Pag. 17.98 - 17.106

Valvola a Leva Manuale

Rotary Hand Lever Valve
Handhebeventil
Distributeur a Commande Manuelle
Válvula de Leva Manual
Válvula de Alavanca Manual



Serie 12V

Pag. 17.108 - 17.109

Valvola Elettropneumatica Modulare

Modula Solenoid Valve
Modulare Druckluft-elektromagnet-ventile
Ilots de Distribution Pneumatique
Válvulas Electroneumáticas Modulares
Válvulas Eletropneumáticas Modulares



Serie 15V

Pag. 17.111 - 17.144

Solenoidi e Connettori

Solenoid and Connectors
Magnetspulen und Stecker
Bobines et Connecteurs
Bobinas y Conectores
Solenóides e Conectores



Pag. 17.24 - 17.29 / 17.75

VALVOLE ELETTROPNEUMATICHE, PNEUMATICHE E MANUALI

MANUAL, PNEUMATIC AND SOLENOID PILOT VALVES

MANUELLE, PNEUMATISCHE & ELEKTROPNEUMATISCHE VENTILE

DISTRIBUTEURS ÉLECTROPNEUMATIQUES, PNEUMATIQUES & MÉCANIQUES

VÁLVULAS ELECTRONEUMÁTICAS, NEUMÁTICAS Y MANUALES

VÁLVULAS ELETRO-PNEUMÁTICAS, PNEUMÁTICAS E MANUAIS



Serie Valves

Serie 04V

VALVOLE A PANNELLO, PULSANTI E SELETTORI

PANEL VALVE, PUSH BUTTONS AND SELECTORS

MIKROVENTILE FÜR SCHALTТАFELEINBAU, DRUCKTASTER UND SCHALTER

DISTRIBUTEURS POUR COMMANDES EN PANNEAU ET BOUTONS

VÁLVULAS DE PANEL, PULSADORES Y SELECTORES

VÁLVULA PARA PAINEL, BOTÕES E SELETOR



MICROVALVOLE

MICROVALVE
MIKRO VENTILE
MICRODISTRIBUTEURS
MICROVÁLVULAS
MICRO-VÁLVULA

3/2 Vie - Ways - Wege - Voies - Vías - Vias

MICROVALVOLE A PUNTALE

TAPPET MICROVALVE
STÖBEL - MIKROVENTIL
MICRODISTRIBUTEUR À POUSSOIR
MICROVÁLVULA DE PUNTAL
MICRO-VÁLVULA DE ACIONAMENTO DIRETO NO PINO

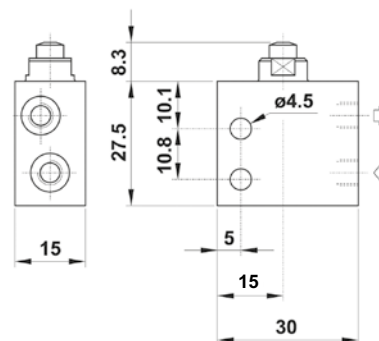
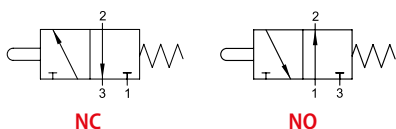

Codice Code Nummer Code Código Código	Vie Ways Wege Voies Vías Vias	Funzione Function Funktion Fonction Función Funções	Misura Size Größe Dimension Medida Tamanho	Pack.
02V G0 3 NC B5	3/2	NC	M5	1
02V G0 3 NO B5	3/2	NO	M5	1

3/2 Vie - Ways - Wege - Voies - Vías - Vias

MICROVALVOLE PER ATTUATORE DA PANNELLO

MICROVALVE FOR PANEL MOUNTING ACTUATOR
STÖBEL - MIKROVENTIL, SCHALTAFELEINBAU
MICRODISTRIBUTEUR À POUSSOIR, MONTAGE EN PANNEAU
MICROVÁLVULA PARA ACTUADORES DE PANEL
MICRO-VÁLVULA PARA ATUADOR DE PAINEL

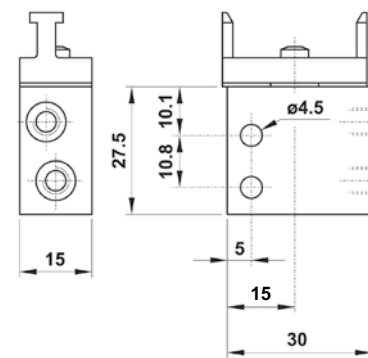
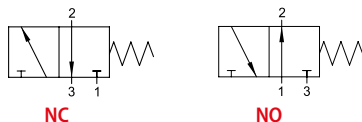

Codice Code Nummer Code Código Código	Vie Ways Wege Voies Vías Vias	Funzione Function Funktion Fonction Función Funções	Misura Size Größe Dimension Medida Tamanho	Pack.
02V D0 3 NC B5	3/2	NC	M5	1
02V D0 3 NO B5	3/2	NO	M5	1

INTERFACCIA PER ATTACCO PULSANTE

INTERFACE FOR CONNECTION BUTTON
ADAPTER ZUM ANSCHLUSS VON TASTEN
ADAPTATEURS POUR BOUTONS DE COMMANDE
INTERFACE PARA CONEXIÓN PULSADOR
INTERFACE PARA MONTAGEM DE BOTÃO



Codice Code Nummer Code Código Código		Pack.
04V 06 0 00 01	SINGOLA - SINGLE - EINZELN - UNIQUE - INDIVIDUAL - SIMPLES	1
04V 06 0 00 02	DOPPIA - DOUBLE - DOPPELT - DOUBLE - DOBLE - DUPLA	1



PULSANTI E SELETTORI

PUSH BUTTON AND SELECTOR
 DRUCKTASTER UND SCHALTER
 BOUTONS POUSSOIRS OU TOURNANTS
 PULSADORES Y SELECTORES
 BOTÕES PULSANTES E SELETORES

PULSANTE PROTETTO

PROTECTED PUSH BUTTON
 DRUCKTASTER, VERSENKT
 BOUTON POUSSOIR, AFFLEURANT
 PULSADOR CON PROTECCIÓN
 BOTÃO PULSANTE PROTEGIDO

Codice Code Nummer Code Código Código	Colore Standard Standard Color Standard Farbe Couleur Standard Cores Standard Cores Padrão	Pack.
04V 01 0 00 01		1

Codice Code Nummer Code Código Código	Colore Color Farbe Couleur Cores Cores	Pack.
04V 01 P 00 VE		1
04V 01 P 00 GI		1
04V 01 P 00 AZ		1



I seguenti colori sono disponibili ordinandoli in aggiunta al kit standard.

The following colors can be ordered separately.

Folgende Farben können separat bestellt werden.



Les couleurs ci-dessus peuvent être commandées séparément.

Los siguientes colores están disponibles añadiéndolos al kit standard.

As seguintes cores estão disponíveis quando compradas em conjunto com o kit standard.

FUNGO MONOSTABILE ASSIALE

AXIAL MONO-STABLE MUSHROOM
 PILZDRUCKTASTER, MONOSTABIL
 BOUTON COUP DE POING, MONOSTABLE
 SETA MONOESTABLE AXIAL
 COGUMELO MONOESTÁVEL AXIAL

Codice Code Nummer Code Código Código	Colore Color Farbe Couleur Cores Cores	Pack.
04V 02 0 0N 01		1
04V 02 0 0R 01		1



FUNGO SBLOCCO A ROTAZIONE

TURN TO UNLOCK MUSHROOM
 PILZDRUCKTASTER, DRUCK-DREH-TASTE
 BOUTON COUP DE POING, POUSSER-TOURNER
 SETA SEGURIDAD DESBLOCAJE A ROTACIÓN
 COGUMELO COM TRAVA POR ROTAÇÃO

Codice Code Nummer Code Código Código	Colore Color Farbe Couleur Cores Cores	Pack.
04V 02 0 0R 02		1

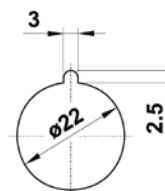

Foro per montaggio a pannello con asola antirotazione.

Panel mounting hole with antirotation feature.

Einbauausschnitt mit Verdrehsicherungs-Bohrung.

Implantation avec trou anti-rotation.

Taladro para montaje a panel con dispositivo antirotación.

Furo para montagem em painel com encaixe anti- rotação.

SELETTORE A CHIAVE

KEY SELECTOR
SCHLÜSSELSCHALTER
BOUTON TOURNANT, À CLÉ
SELECTOR DE LLAVE
SELETOR COM CHAVE

Codice Code Nummer Code Código Código	Colore Color Farbe Couleur Cores	Funzione Function Funktion Fonction Función Funções	Posizione estrazione chiave Position to pull the key out Schlüsselabnahme Retrait de clé Posición extracción llave Posição de retirada da chave	Pack
04V 03 0 00 01	■	0 - 1	Solo centrale Only in central position Nur in zentraler Position Que dans la position centrale Sólo central Central	1
04V 03 0 00 02	■	0 - 1	Ambedue Both position Beide Les deux Ambas posiciones Ambas as posições	1
04V 03 0 00 03	■	2 - 0 - 1	Solo centrale Only in central position Nur in zentraler Position Que dans la position centrale Sólo central Central	1

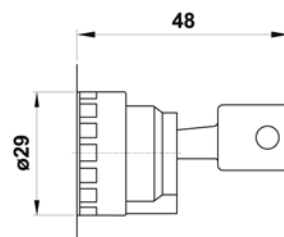

SELETTORE A LEVA CORTA

SHORT LEVER SELECTOR
DREHSCHALTER
BOUTON TOURNANT
SELECTOR DE LEVA CORTA
SELETOR DE ALAVANCA CURTA

Codice Code Nummer Code Código Código	Colore Color Farbe Couleur Cores	Funzione Function Funktion Fonction Función Funções	Pack.
04V 04 0 0N 01	■	0	1 1
04V 04 0 0N 02	■	0	1 1
04V 04 0 0N 03	■	2	0 1 1
04V 04 0 0N 04	■	2	0 1 1

→ : Ritorno a molla
Spring return
Federrückstellung
Rappel par ressort
Retorno muelle
Retorno por mola

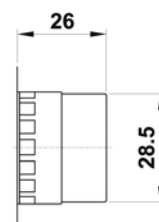

SELETTORE A LEVA LUNGA

LONG LEVER SELECTOR
DREHHEBEL
BOUTON TOURNANT À LEVIER
SELECTOR DE LEVA LARGA
SELETOR DE ALAVANCA LONGA

Codice Code Nummer Code Código Código	Colore Color Farbe Couleur Cores	Funzione Function Funktion Fonction Función Funções	Pack.
04V 05 0 0N 01	■	0	1 1
04V 05 0 0N 02	■	0	1 1
04V 05 0 0N 03	■	2	0 1 1
04V 05 0 0N 04	■	2	0 1 1

→ : Ritorno a molla
Spring return
Federrückstellung
Rappel par ressort
Retorno muelle
Retorno por mola

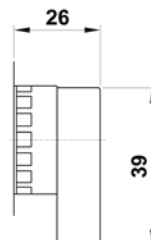



Aignep si riserva il diritto di variare modelli e ingombri senza preavviso.
Aignep reserves the right to vary models and dimensions without notice.
Aignep behält sich das Recht vor, Daten ohne Ankündigung zu ändern.
Aignep se réserve le droit de modifier les données sans préavis.
Aignep reserva-se o direito de alterar os modelos e dimensões sem prévio aviso.

Aggiornamento - Updated - Stand - Mise à jour - Actualización - Atualização: 11/2018



AIGNEP SPA
Via Don G. Bazzoli - 34
25070 Bione (BS)
ITALY

T: +39 0365 896626
F: +39 0365 896561

aignep.it@aignep.com



AIGNEP IBERICA SA
Pol. Ind. el Tortuguer "Can Prat"
Naves 23 y 24 08691
Monistrol de Montserrat - Barcelona
SPAIN

T: +34 93 828 47 36
F: +34 93 828 44 32

aignep.es@aignep.com



**AIGNEP DO BRASIL COMERCIO DE
COMPONENTES PARA AUTOMAÇÃO LTDA**
Rua Campos Mello, 185
Vila Mathias - 11015-011 - Santos/SP
BRASIL

T: +55 13 2138 4049
F: +55 13 2138 4052

aignep.br@aignep.com



AIGNEP USA LLC
7121 Loblolly Pine Blvd
Fairview, TN 37062
U.S.A.

T: +1 615 771 6650
F: +1 615 771 0926

aignep.usa@aignep.com



AIGNEP AG
Industriestrasse 22A
2545 Selzach
SWITZERLAND

T: +41 32 342 09 09
F: +41 32 342 09 11

aignep.ch@aignep.com



AIGNEP FRANCE SARL
2, Avenue des Améthystes
44338 Nantes Cedex 3
FRANCE

T: +33 02 72 24 26 50
F: +33 02 72 24 26 51

aignep.fr@aignep.com



AIGNEP LATAM
Sede:
Calle 15 N 27-78 Local 2
Sec. Paloquemao - 111411
Bogota
COLOMBIA

T: +57 1 37 52 50 1
T: +57 1 37 52 50 8

Sucursal:
Calle 6 SUR 52-80 Local 19
Cc. El Rodeo - 0520024 Medellin
COLOMBIA

T: +57 4 58 70 90 1

aignep.latam@aignep.com



**AIGNEP (Wuxi) FLUID
TECHNOLOGY CO., LT D.**
NO 8, Yanggong Road, Nanhu Main Road
Wuxi, Jiangsu.
CHINA

T: 0510-8544 1923
F: 0510-8540 0223

aignep.cn@aignep.com

www.aignep.com