



**ADVANCED FLUID  
MANAGEMENT SOLUTIONS**

**An overview of the RAASM world**



**RAASM**





founded in 1975





*the human side  
of Quality*





# STUDY, RESEARCH AND DESIGN

The real strength of a firm starts with the ability of its study and research departments to always find the most suitable solutions to address market demands.

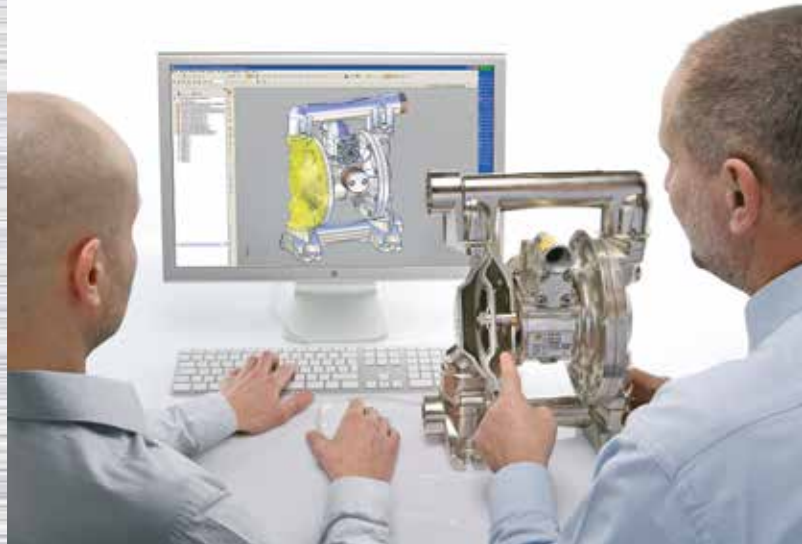

# TESTING AND INSPECTIONS

A sophisticated test room enables careful testing of the quality of new products before they are put on the market.

# ASSEMBLY LINES

Dedicated equipment specially designed to facilitate assembly operations, at the same time allowing an effective and automatic control of quality.





# STORAGE OF COMPONENTS

Our vertical stores enable quick and careful preparation of the components and spare parts intended for assembly and sale.



**TECHNOLOGY**  
**INNOVATION**  
**QUALITY**  
**SAFETY**  
**RELIABILITY**



# TECHNICAL ASSISTANCE

The aim is to always respond fully to the questions of our customers and meet all their needs.





# BRAKE BLEEDERS, TYRE INFLATORS, WASH AND DEPLETED OIL COLLECTION

## BRAKE BLEEDERS



With 2 or 3 chambers 5 l



Automatic filling 13 l



With inflation gun 13 - 24 l

## PORTABLE INFLATORS



With brush or by dipping 65 l

## WASHING TANKS AND NON-TOXIC SPRAYERS



AISI 304 st. steel 24 l



Painted steel 16 - 24 l

## PIT OR FLOOR DRAINERS



Adjustable trolley 65 - 110 - 150 l



With or without exchange pump 50 - 95 - 150 l



## DEPLETED OIL DRAINERS



Central or side sump 65 - 90 - 115 l



With or without prechamber 65 - 90 - 115 l



With pantograph 65 - 115 l



Wall mounted pneumatic kit

# OIL AND GREASE DISPENSING

## HAND-OPERATED PUMPS - PNEUMATIC DISPENSERS GREASERS 13 kg



Double-acting manual pump 16 - 24 l

Air-operated 8-10 bar 16 - 24 l

With lever or pedal 400 bar 13 kg

High pressure 350 bar transfer 20 bar

## AIR-OPERATED OIL AND GREASE PUMPS

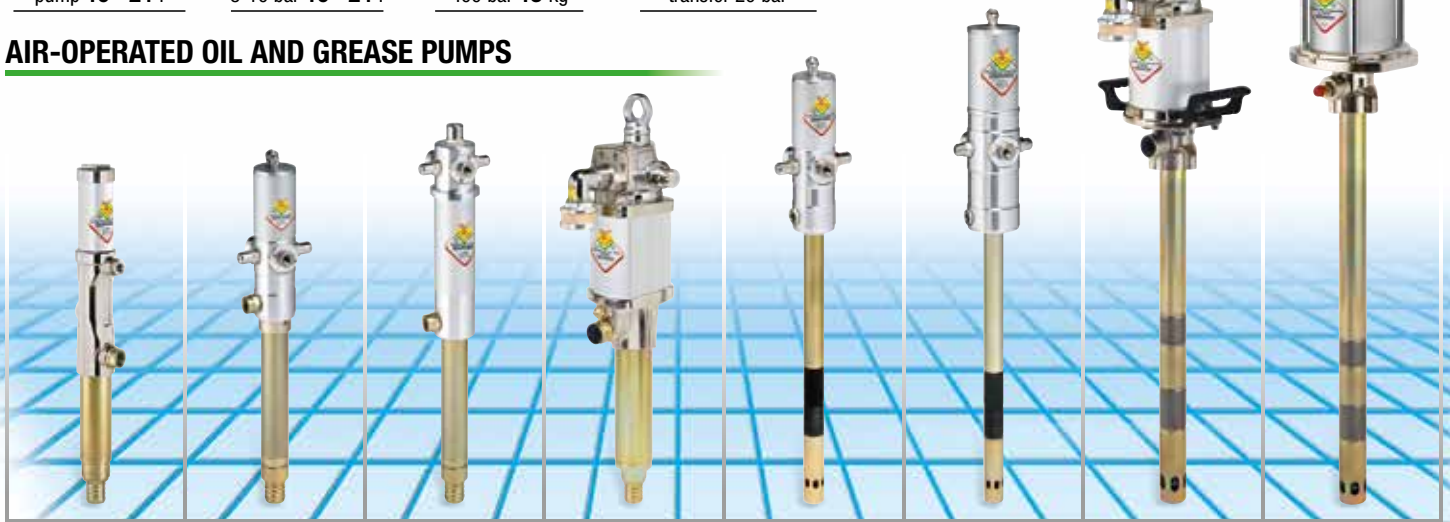

Series 500  
R 1:1-35 l/min  
Viton® seals

Series 600  
R 3:1-14 l/min  
NBR seals

Series 650  
R 5:1-18 l/min  
NBR seals

Series 900  
R 5:1-45 l/min  
PU seals

Series 600  
R 50:1-1500 g/min  
PU seals

Series 700  
R 65:1-1900 g/min  
PU seals

Series 900  
R 45:1-4400 g/min  
PU seals

Series 1500  
R 70:1-7000 g/min  
PU seals

## OIL AND GREASE DISPENSING KITS

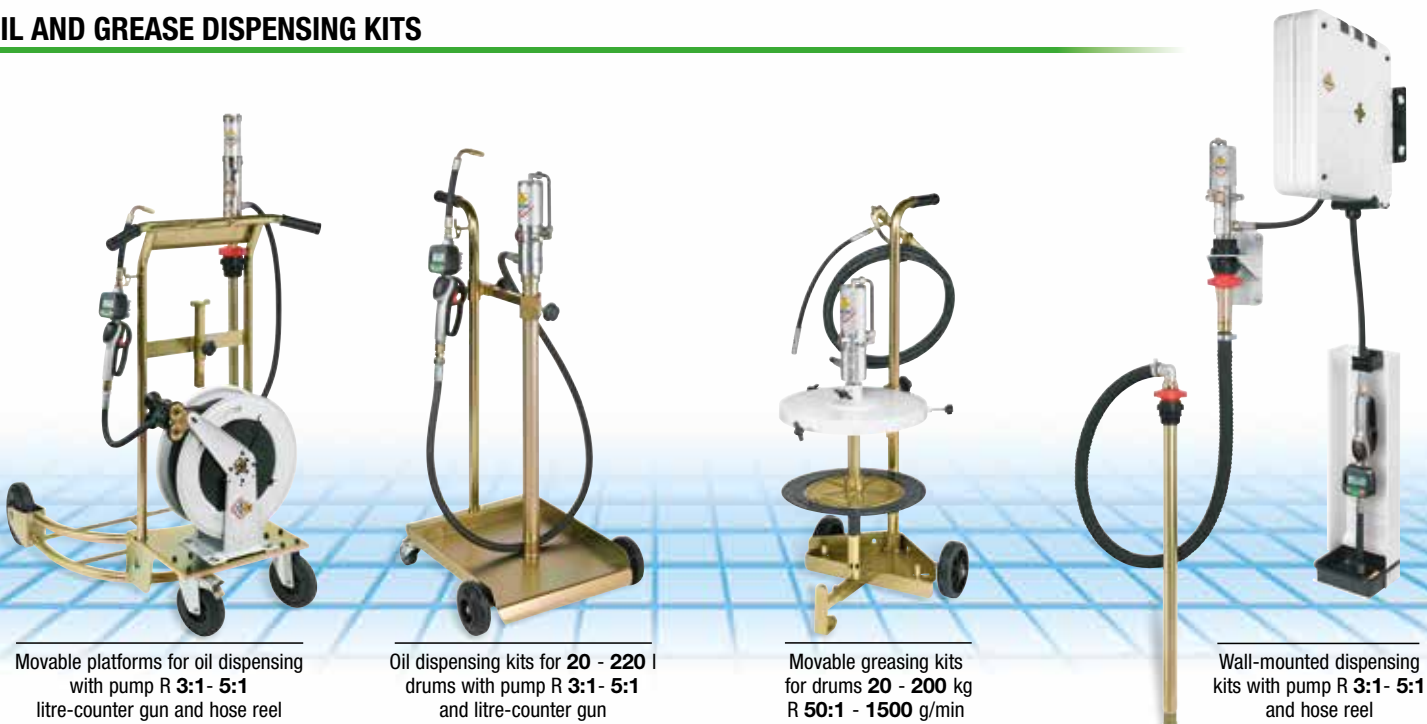

Movable platforms for oil dispensing with pump R 3:1 - 5:1 litre-counter gun and hose reel

Oil dispensing kits for 20 - 220 l drums with pump R 3:1 - 5:1 and litre-counter gun

Movable greasing kits for drums 20 - 200 kg R 50:1 - 1500 g/min

Wall-mounted dispensing kits with pump R 3:1 - 5:1 and hose reel



# DISPENSER GUNS, LITRE COUNTERS, PULSERS, SERVICE COLUMNS, FLUID CONTROL SYSTEM

## DISPENSER GUNS



S. 1/2" for oil.  
Delivery 40 l/min



S. 1/2" for oil.  
Delivery 65 l/min



S. 3/4" for oil.  
Delivery 70 - 85 l/min



S. 1/2" for antifreeze  
and windshield washing  
liquid. Delivery 40 l/min



## DIGITAL LITRE COUNTERS AND PULSER FOR OIL, DIESEL FUEL, ANTIFREEZE AND WINDSHIELD FLUID



Series 1/2"  
Delivery 35-40 l/min

Series 3/4"  
Delivery 70-90 l/min

Series 1"  
Delivery 100-120 l/min

## FLUID CONTROL SYSTEM

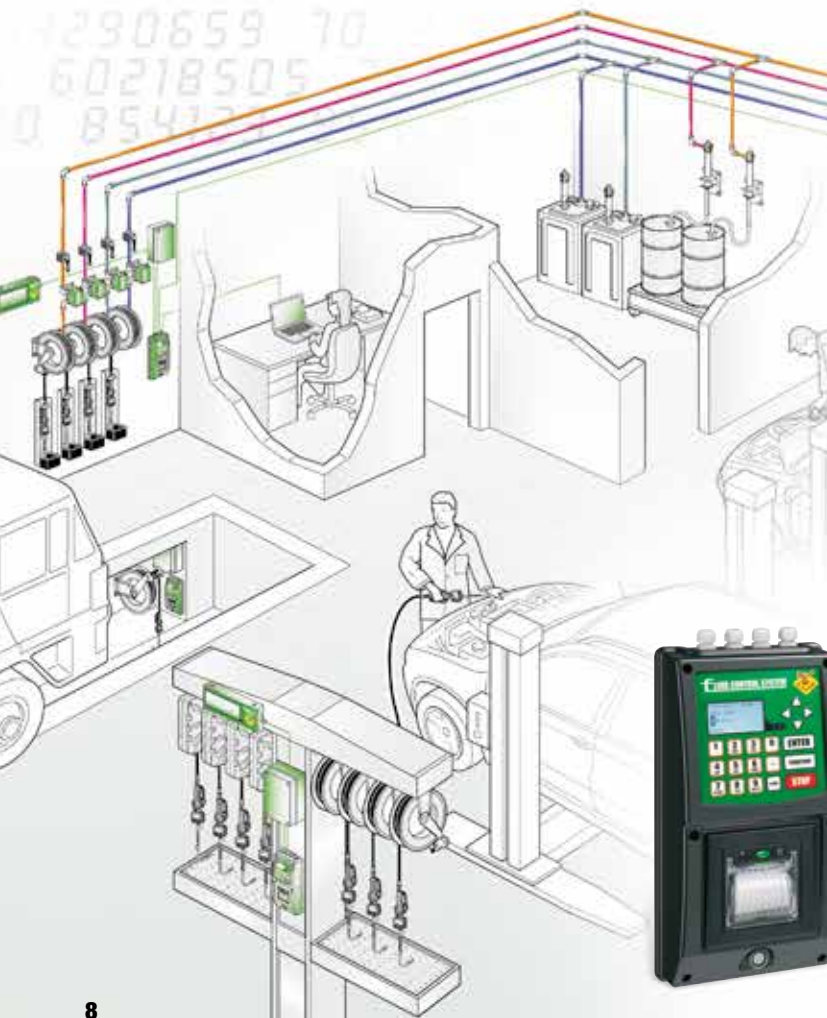

Operator control  
unit (OCU)

Service  
columns



# INDUSTRIAL AND DIAPHRAGM PUMPS, RAM HOISTS

## DIAPHRAGM PUMPS IN ALUMINIUM R 1:1



In accordance with directive Atex



Series 120-AB  
1/2" - 70 l/min



Series 1000-AB  
1" - 170 l/min



Series 1140-AB  
1.1/4" - 200 l/min



Series 1120-AB  
1.1/2" - 480 l/min



Series 2000-AB  
2" - 560-610 l/min

### AVAILABLE DIAPHRAGMS

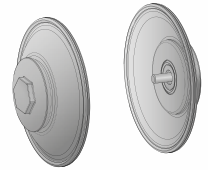

- > NBR HIGH NITRIL
- > HYTREL®
- > EPDM
- > SANTOPRENE™
- > PTFE + HYTREL®

## POLYPROPYLENE DIAPHRAGM PUMPS - MOTOR IN ALUMINIUM R 1:1



Series 120-PB  
1/2" - 60 l/min



Series 120-PB  
1/2" - 60 l/min  
double inlet



Series 1000-PB  
1" - 170 l/min



Series 1000-PB  
1" - 170 l/min  
double inlet



In accordance with directive Atex

## POLYPROPYLENE DIAPHRAGM PUMPS - MOTOR IN POLYPROP. R 1:1



Series 120-PPB  
1/2" - 60 l/min



Series 120-PPB  
1/2" - 60 l/min  
double inlet



Series 1000-PPB  
1" - 170 l/min



Series 1000-PPB  
1" - 170 l/min  
double inlet

## INDUSTRIAL AIR-OPERATED PUMPS OIL, GREASE AND INDUSTRIAL FLUIDS



In accordance with directive Atex



Oil and industrial fluids  
S. 900 R. 2:1 ÷ 11:1  
30 ÷ 95 l/min  
Grease R. 45:1 ÷ 70:1  
3 ÷ 4,4 kg/min



Oil and industrial fluids  
S. 1200 R. 3:1 ÷ 18:1  
23 ÷ 100 l/min  
Grease R. 40:1 ÷ 75:1  
4,4 ÷ 10 kg/min



Industrial fluids  
S. 1800 R. 5:1 ÷ 8:1  
65 ÷ 90 l/min



Oil and industrial fluids  
S. 1500 R. 4:1 ÷ 6:1  
80 ÷ 110 l/min  
Grease R. 70:1  
7 kg/min



Ram hoists



# HOSE REELS FOR FLUID AND CABLE REELS

## WHEN CHOOSING A HOSE REEL IT IS IMPORTANT TO CONSIDER:

- type of fluid to be dispensed
- delivery in l/min to be dispensed
- length and width of the hose to be used
- pressure of the fluid

Air-Water <b>20/400 bar</b>
Oil and allied products <b>150 bar</b>
Grease <b>400 bar</b>
Diesel fuel <b>10 bar</b>
AdBlue® <b>10 bar</b>
Oil-Water <b>200 bar</b>
Oil-Paints <b>200 bar</b>
Welding <b>20 bar</b>
LPG-methane <b>20 bar</b>

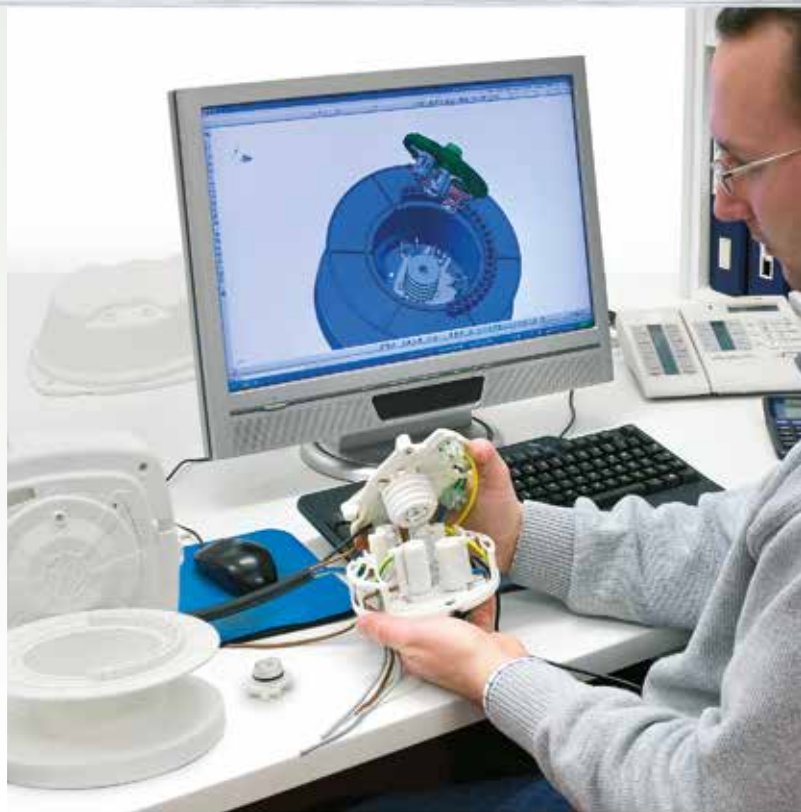

You can choose some hose reels versions with different colours besides the standard one	<b>RAL 7035</b>	<b>RAL 1004</b>	<b>RAL 3020</b>	<b>RAL 5002</b>	<b>RAL 9005</b>
<b>RANGE OF HOSES</b>	<b>POLYURETHANE</b>	<b>BLACK SYNTHETIC RUBBER</b>	<b>HYGIENIC HOSE</b>	<b>RUBBER SBR/EPDM ISO 3821</b>	<b>RUBBER NBS/PVC ISO 3821</b>

## CABLE REELS

### Advantages



- Electric collector designed for better performances also with high currents.
- Thermal protector against overheating of the rewinded cable mounted in all the models.
- IP44 protection degree provided for all the electrical parts.
- Spring tested for more than 10 working years with the possibility to easily adjust the rewinding force.
- Cable guide with rollers equipped with 4 rollers in each model designed to save the work life of the cable.
- Different options for different needs: rewinding clutch, bayonet bracket and protection cap.





## FIXED AND ADJUSTABLE INDUSTRIAL SERIES IN PAINTED STEEL AND AISI 304 - AISI 316 STAINLESS STEEL

Supplied with hose in black synthetic rubber or hygienic blue rubber



available with automatic hose guide rollers



In accordance with directive ATEX



available with automatic hose guide rollers

## STANDARD SERIES WITH ENCLOSURE IN TECHNOPOLYMER, PAINTED STEEL OR AISI 304 STAINLESS STEEL

Supplied with polyurethane hose



## STANDARD SERIES IN PAINTED STEEL

Supplied with polyurethane hose

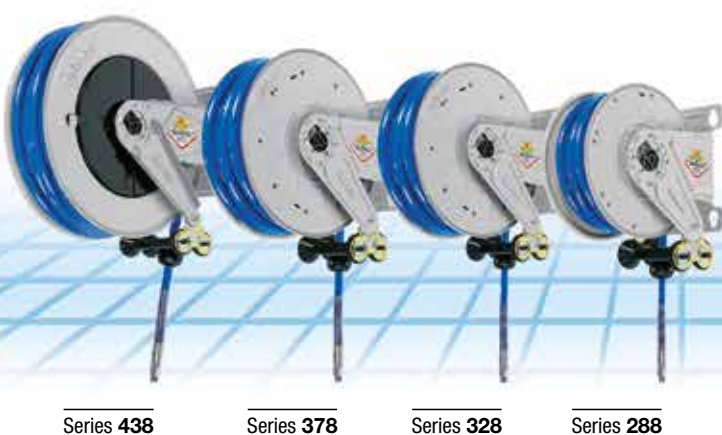

### HOSE CHARACTERISTICS

- ✓ Polyurethane hose (blue) with protection spring on fittings.
- ✓ Brass swivel joint pipe outbound.
- ✓ Brass fittings.
- ✓ Length in entrance 1,5 m.

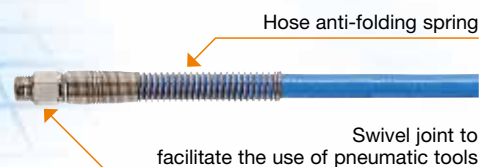



## INDUSTRIAL SERIES WITH DRUM IN SHOCKPROOF ABS, OPEN OR ENCLOSED VERSION

With supporting structure in painted steel or AISI 304 stainless steel

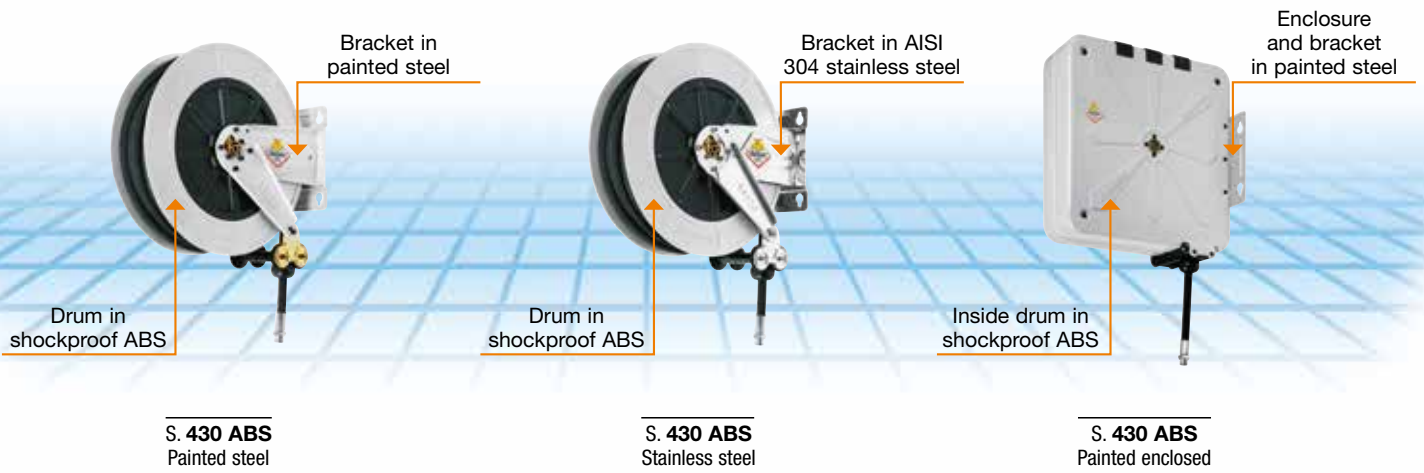

## INDUSTRIAL SERIES FOR SPECIFIC APPLICATIONS



In accordance with directive ATEX

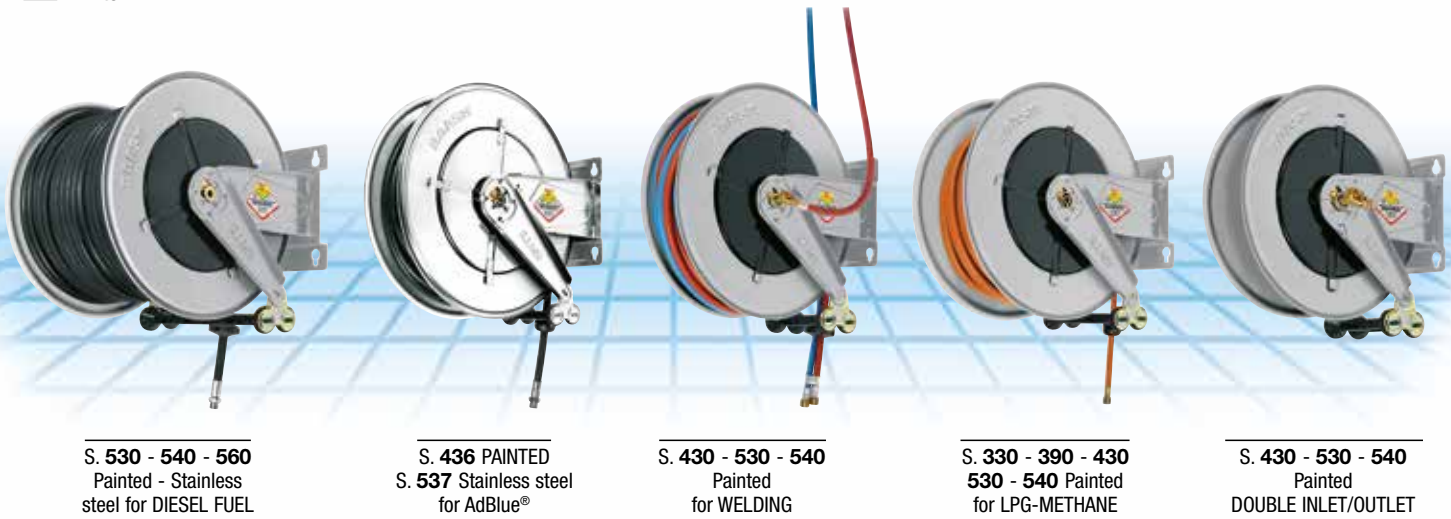

## MANUAL SERIES WITH SECURITY SYSTEM

In painted steel or stainless steel AISI 304 - 316



In accordance with directive ATEX



## SECURITY SYSTEM

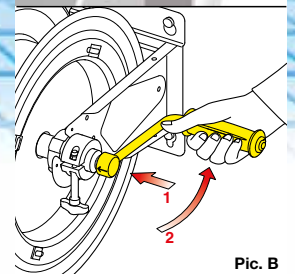
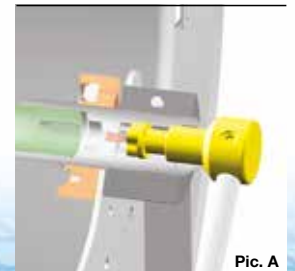

The hose reel is designed with a **new security system** that allows the handle to stay in place, avoiding the rotation during the manual hose unreeling (Picture A - B).



**SERIES 500 HOSE REELS IN PAINTED STEEL**

With security system



Width 240 - 320 - 460 - 600 mm

**TROLLEY MOUNTED HOSE REELS**

In painted steel or stainless steel AISI 304 - 316



Manual s. 530 - 540 - 560

**SERIES 600 MOTORIZED HOSE REELS IN PAINTED STEEL**

Available with hydraulic or pneumatic motor with 1" or 1.1/2" passage



Series 617 - 637 Hydraulic  
width 220 - 400 mm



Series 618 - 638 Pneumatic  
width 220 - 400 mm

**SERIES 700 MANUAL AND MOTORIZED HOSE REELS IN PAINTED STEEL**

Available with various motorizations with 2" passage



Manual

Electric 230V

MANUAL	ELECTRIC 24V
HYDRAULIC	PNEUMATIC



## CABLE REELS SERIES 280 - ENCLOSED HOSE REELS SERIES 280 Air-Water



**S. 280**  
400 V Three phase  
without socket

**S. 280**  
230 V Single phase with socket  
and Schuko plug

**S. 280**  
Air-Water  
20 bar / 40 °C

REWINDING  
CLUTCH



"SPEED CONTROL"

PROTECTION CAP



BAYONET BRACKET



## CABLE REELS SERIES 280 - 290 with lamp



**S. 280**  
Without transformer  
fluorescent portable lamp and led

**S. 290**  
With transformer 230 V  
led portable lamp

**S. F230 - F12 - F24**  
Fluorescent lamp  
**S. L1224**  
Led lamp

SWIVELLING HOOK



PROTECTED SWITCH



## GROUNDING CABLE REEL - Enclosed cable reel SERIES 280 - Cable reel SERIES 350



In accordance  
with directive  
Atex



EXAMPLE OF  
OPERATION

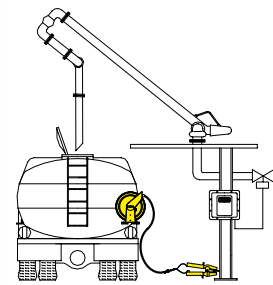
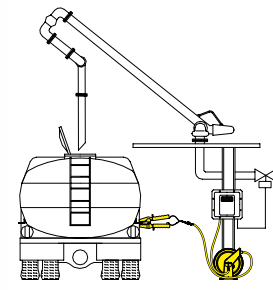

EARTHING PLIERS  
100A



EARTHING PLIERS  
50A



ANTI-DEFLAGRATION  
EARTHING PLIERS 10A





**RAASM** products  
are present worldwide through a network of  
qualified dealers.





# IDEAL FOR THE FOLLOWING **SECTORS**

- **AUTOMOTIVE**
- **MECHANICAL INDUSTRY**
- **CHEMICAL INDUSTRY**
- **TANNING INDUSTRY**
- **WOOD INDUSTRY**
- **MARBLE INDUSTRY**
- **MANUFACTURING INDUSTRY**
- **MINING SECTOR**
- **AGRICULTURE**
- **BUILDING**
- **ROAD WORKS**
- **BOATING**
- **AVIATION**
- **CIVILIAN AND MILITARY AIRPORTS**
- **RAILWAY SECTOR**



Authorized dealer



Company with an  
ISO 9001:2015  
certified quality  
management system

**RAASM S.p.A.**  
36022 S. ZENO DI CASSOLA (VI) - Via Marangoni, 33 - ITALY

**Export department**  
Tel. +39 0424 571130 - Fax +39 0424 571135

**Technical department**  
Tel. +39 0424 571150 - Fax +39 0424 571155  
info@raasm.com - www.raasm.com

